

DEVELOPMENT OF HIGH RF POWER DELIVERY SYSTEM FOR 1300 MHz SUPERCONDUCTING CAVITIES OF CORNELL ERL INJECTOR*

S. Belomestnykh[#], M. Liepe, V. Medjizade, H. Padamsee, V. Veshcherevich,
Laboratory for Elementary-Particle Physics, Cornell University, Ithaca, NY 14853, USA
N. Sobenin, Moscow Engineering Physics Institute (State University), Moscow, Russia

Abstract

Development of a 150 kW CW RF power delivery system for 1300 MHz superconducting cavities is under way at Cornell University in collaboration with MEPHI. The system is based on a twin-coupler consisting of two identical coaxial antenna-type couplers derived from the TTF III input coupler design. Because the average power is much higher than in the TTF III coupler, the required coupling is stronger and to avoid multipacting phenomena, major changes were made to the prototype design. Presented coupler has completely redesigned cold part and significantly improved cooling of warm bellows. The results of thermal and mechanical stress calculations are reported. The magnitudes and phases of RF fields applied to each side of the twin-coupler must be very close to each other. This imposes very strict requirements upon a power dividing system. These requirements and proposed layout of a system satisfying them are discussed.

INTRODUCTION

In the Cornell Energy Recovery Linac project (ERL) [1], each of the two-cell 1300 MHz injector cavities will deliver 100 kW of CW RF power to the 100 mA beam. Individual 150 kW klystrons will drive the cavities via high-power delivery systems. Each system consists of a twin input coupler [2] and a waveguide distribution network with an adjustable hybrid and a two-stub phase tuner for precise setting of RF power split. The twin coupler consists of two identical antenna type couplers, and the magnitudes and phases of RF fields applied to each of these couplers must be very close to each other. A difference of field magnitudes on individual coupler antennae should not exceed 1-2%, and a phase difference should not exceed 1° [2]. A scheme of the power dividing system for ERL injector cavities is shown in Figure 1. This paper describes latest results in developing components of the high power delivery system that would satisfy such strict requirements.

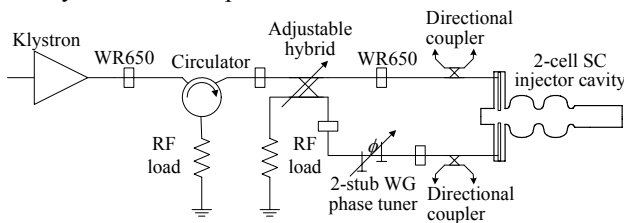

Figure 1: RF power splitting scheme for ERL injector.

*Supported by Cornell University
#sab@lepp.cornell.edu

POWER SPLIT

We proposed to use a short slot hybrid as a power divider for this precise RF power dividing system [3]. This type of hybrids seems to have better electrical properties compared with other four-port hybrid designs: low sensitivity to mismatch, a wide frequency band, and the best high power handling. For power balance, an adjustable stub in the middle point of the short slot hybrid can be used. By varying its penetration into the waveguide, one can adjust the power ratio between hybrid output arms with a very small phase error. Two versions of an adjustable short slot hybrid design were studied recently [4]. The first one uses uniform standard waveguide arms of the WR650 type and has a narrower frequency band. The second one uses narrower waveguide arms and needs additional transition pieces for connection to standard waveguides. On the other hand, it has a wider frequency band. Both types are adequate to the Cornell ERL RF system.

A two-stub device can be used as a phase tuner. Insertion of a stub into a waveguide produces capacitive admittance and an additional phase shift, these two values depending on the depth of the stub insertion. Using optimal stub separation one can reach the phase range of 20° keeping reflection below -40 dB [3].

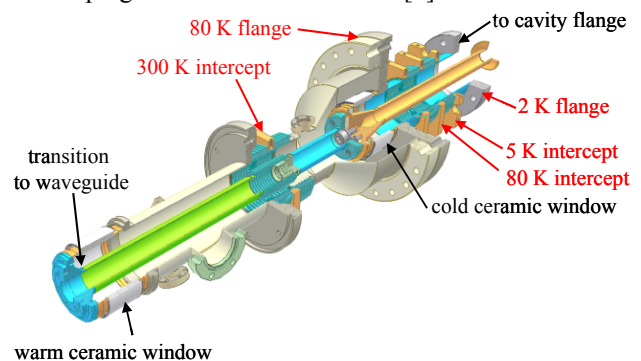

Figure 2: 3D view of the injector cavity coupler.

INPUT COUPLER

A design of the coaxial antenna type couplers is derived from the TTF III input coupler [5]. The following major modifications were made to meet our requirements. The cold part of the original coupler was completely redesigned. Instead of a 40 mm 70 Ω coaxial line, a 62 mm 60 Ω line was chosen for stronger coupling, better handling the high power and avoiding multipacting [2]. The coupler has large profiled antenna tip and the 16 mm travel range for getting the required coupling variation.

The antenna is made of a copper tube. In the cold window a bigger ceramic cylinder is used (similar to the one used in the warm window but with a reduced height). The weakest points of the TTF III coupler at high average power levels are the bellows, which are not cooled. This problem is solved in the new design by i) providing forced air cooling of inner conductor bellows of the warm coax line and ii) adding more heat intercepts to outer conductor bellows of the cold and warm coaxial lines. The general design of the coupler is shown in Figure 2. A careful thermal analysis [6] of the coupler confirmed that the design changes are adequate. Figure 3 illustrates temperature distributions along bellows. Although simulations showed that maximum temperature of the warm ceramics does not exceed 90°C, there is significant azimuthal temperature gradient (Figure 4) so that local cooling by compressed air will be required. The coupler heat loads are approximately 0.17 W to 2 K, 2.5 W to 5 K, and 70 W to 80 K at RF power of 75 kW CW in traveling wave mode. Mechanical stress calculations did not reveal any problems in the proposed design.

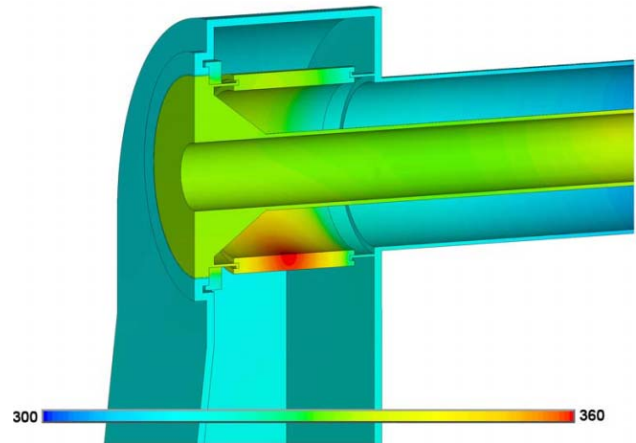

Figure 4: Temperature map of the warm window.

The cold outer conductor bellows must have a support that would provide means for alignment and would not increase significantly static heat leak to the 5 K heat intercept. The design we chose is shown in Figure 5. It allows vertical and horizontal alignment and free longitudinal movement.

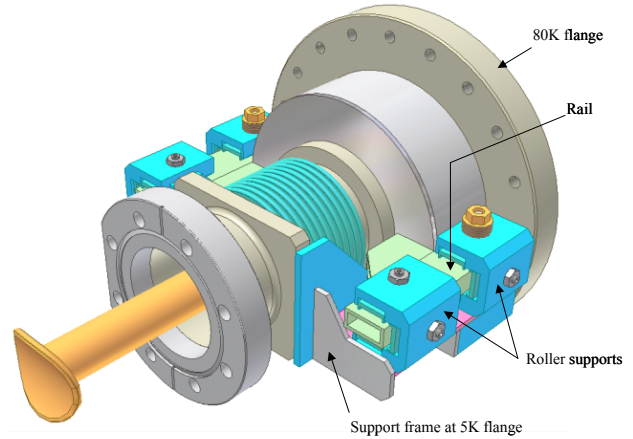

Figure 5: Alignment of the cold part of the input coupler.

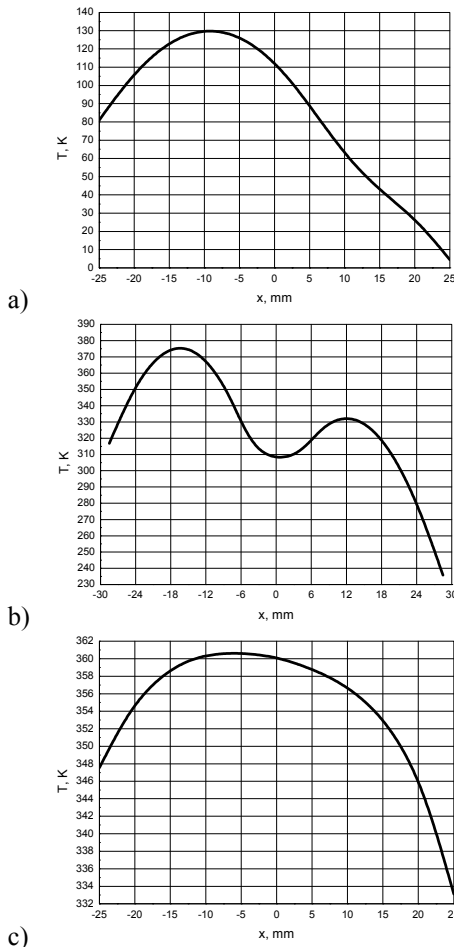

Figure 3: Temperature distribution at 75 kW CW in traveling wave along: a) cold bellows, b) warm outer conductor bellows, and c) warm inner conductor bellows.

TUNING THE SYSTEM

The very strict requirements to the power split come from desire to avoid field asymmetry that would transversely kick the beam traveling on axis and produce an emittance growth [2]. A procedure has to be developed to precisely tune the power delivery system. To assist in tuning, we proposed to use an equivalent diagram (Figure 6). Here RF power split with associated amplitude and phase errors are represented by two sources with corresponding amplitudes A_1 and A_2 and phases ϕ_1 and ϕ_2 . Two antennae have capacitive coupling (represented by C_1 and C_2) to the cavity (R/Q , Q_0 , f_{res}), to the ground (C_{10} and C_{20}), and to each other (C_{12}). Parameters of the equivalent diagram were calculated as functions of the antenna penetration depth (Figure 7) using Microwave Studio® [7]. At nominal coupling ($Q_{ext} = 9.2 \times 10^5$) the capacitance values are: $C_{10} = 2.95$ pF, $C_1 = 0.00859$ pF, $C_{12} = 0.116$ pF. Using the

equivalent diagram allows us to make predictions easily and will help in interpreting the results of measurements.

The accuracy of final magnitude and phase balance depends not only on adjusting devices and tuning procedure, but also and mainly on measuring techniques and accuracy of measurements. We need to measure and adjust power and phase balance on output arms of the power divider. Also we need to measure phases of each coupler with the waveguide pieces attached to them. Flexible waveguide parts should not be used in waveguide assemblies between power divider and cavity couplers because they are sources of phase errors. We need to use only rigid waveguide pieces and shims. Measurements should be done using a well-calibrated network analyzer with cables being as short as possible (even the use of calibrated cables may lead to non-negligible phase errors due to their bending). The measurements of two individual cavity couplers should be made immediately one after another, using the same calibration.

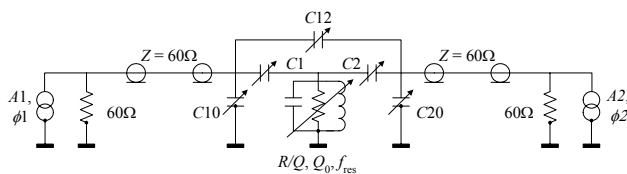

Figure 6: Equivalent diagram.

SUMMARY

The development of the 150 kW CW power delivery system for 1300 MHz superconducting cavities of the Cornell ERL Injector is in progress. The input coupler design is complete and preparations are under way to order first two prototypes from industry. The coupler will have low heat leaks and will provide adjustable coupling to the cavity. A variable power dividing scheme was proposed that would satisfy strict requirements of the ERL injector. An adjustable four-port hybrid and a two-stub waveguide phase shifter have been simulated. To assist in tuning the system, an equivalent diagram was developed and its parameters were calculated.

REFERENCES

- [1] G. Hoffstaetter et al., "The Cornell ERL Prototype Project," PAC'2003, Portland, OR.
- [2] V. Veshcherevich et al., "Input Coupler for ERL Injector Cavities," PAC'2003, Portland, OR.
- [3] V. Veshcherevich, "On Power Splitting for Cornell ERL Injector Cavities," Cornell LEPP Report ERL 04-1, 2004.
- [4] V. Veshcherevich, "An Adjustable Short Slot Hybrid for Precise RF Power Divider System for Cornell ERL Injector Cavities," Cornell LEPP Report ERL 04-3, 2004

- [5] B. Dwersteg, et al., "TESLA RF Power Couplers Development at DESY," Proc. of the 10th Workshop on RF Superconductivity, Tsukuba, Japan, 2001.
- [6] N. Sobenin, et al., "Thermal Calculations of Input Coupler for Cornell ERL Injector Cavities," EPAC'2004, Lucerne, Switzerland.
- [7] CST GmbH, Darmstadt, Germany.

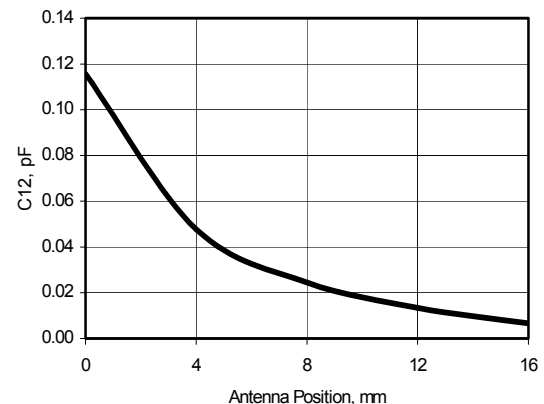
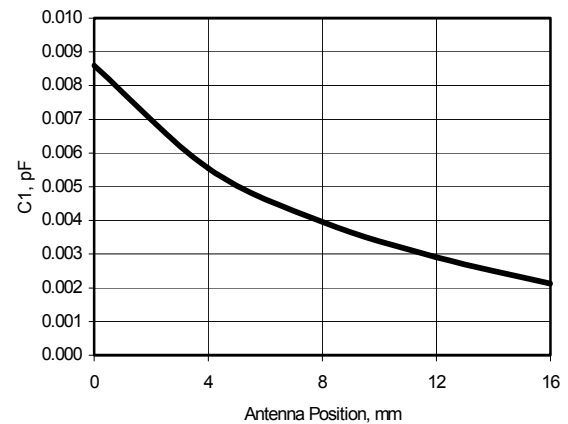
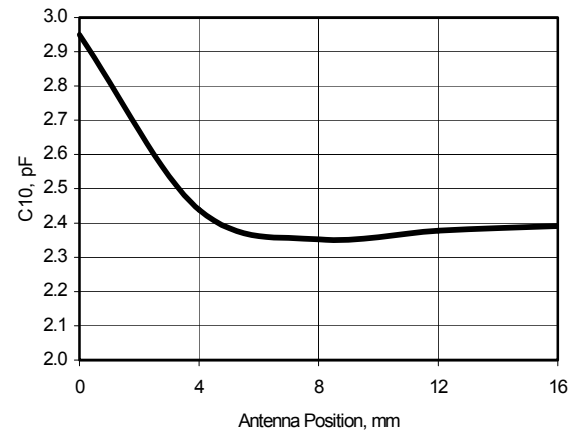

Figure 7: Parameters of the equivalent diagram as function of the antenna position.